



EVOLUTION ELECTRIC VEHICLES INC

California Headquarters: 2620 Palisades Drive, Corona CA 92882
Florida Operations: 7600 Narcoossee Rd, Orlando, FL 32822
909-393-6800 info@evolutionelectricvehicle.com
www.evolutionelectricvehicle.com



D3

Premium Personal
Golf Cart



EVOLUTION
ELECTRIC VEHICLES

All Rights Reserved By Evolution Electric Vehicles.

AN EVOLUTION

IN THE
GOLF CAR
INDUSTRY



3
FACTORIES

6
PRODUCT
LINES

150000
TOTAL SALES

Evolution engages in the R&D, manufacture, and sales of electric vehicles and is the world's leading manufacturer of fleet golf carts, personal, commercial and utility vehicles. The new model D3 is more intelligent, dynamic and self-assured than ever. With a fascinatingly cutting-edge operating system that adapts more accurately to your needs and preferences every day. Nothing appeals to the eye more than an aura of strength and athleticism. With an even more expressive golf cart design, D3's advanced electric powertrain delivers exhilarating performance. The new model has a particularly sporty charisma. Model D3 is an evolution in golf cart.

WHAT ARE THE FEATURES

- 1** INJECTION MOULDED CANOPY
- 2** WINDSHIELD WIPER, AJUSTABLE IN SPEED
- 3** LAMINATED WINDSHIELD
- 4** 9.7 INCH TOUCHSCREEN WITH BACK-UP CAMERA
- 5** AUTOMOTIVE, MULTIFUNCTIONAL STEERING WHEEL
- 6** AUTOMOTIVE STYLE DASH WITH ROOM FOR MORE ACCESSORIES
- 7** 4 SPEAKERS
- 8** MOST LEGROOM IN ITS CLASS
- 9** SPRAY NOZZLES
- 10** FRONT TRUNK WITH A LARGE STORAGE COMPARTMENT
- 11** BOTTLE HOLDER
- 12** LITHIUM BATTERY
- 13** 14" ALLOY WHEEL RIMS WITH COLOR MATCHING
- 14** MACPHERSON FRONT SUSPENSION
- 15** USB CHARGERS KEEP YOU CHARGED ON THE GO
- 16** LED HEADLIGHTS: HIGH BEAM LOW BEAM DAYTIME RUNNING LIGHT TURN SIGNALS
- 17** WIDEST, MOST ERGONOMIC CONTOURED SEAT
- 18** LED LOGO LIGHT
- 19** SEAT BELTS
- 20** RETATABLE ARMREST
- 21** CHARGING PORT
- 22** REAR-FACING FLIP SEAT FOR ADDITIONAL PASSENGERS
- 23** REAR HANDRAIL (OPTIONAL GOLF BAG HOLDER KIT)
- 24** STORAGE COMPARTMENT OR BIULT-IN REFRIGERATOR
- 25** LED BRAKE LIGHTS AND TURNING SIGNALS
- 26** TORSION BEAM SUSPENSION





POWER **STEERING**

D3's Electric Power Steering (EPS) gives you comfort, control and feel-of-the-road, which is a technology that will define the future. It eliminates the need for a power steering pump, hoses, hydraulic fluids, and a drive belt and pulley on the engine. As a result, electric power steering is energy efficient and environmentally compatible - while offering extras like simplified tuning, packaging flexibility and engine-off steering assist. Electric power steering also provides an advantage in regards to physical weight, too, as their far more simple setups reduce the weight over the front axle. When it comes to performance carts, electric power steering allows for more adjustability of the steering. It combines an electric motor with a computer and sensors to determine how much power to apply to the driver's steering depending on the speed of the vehicle. Additionally, this electronic control system goes beyond making steering easier.

**FOUR-WHEEL
HYDRAULIC
PISTON
DISC
BRAKE**

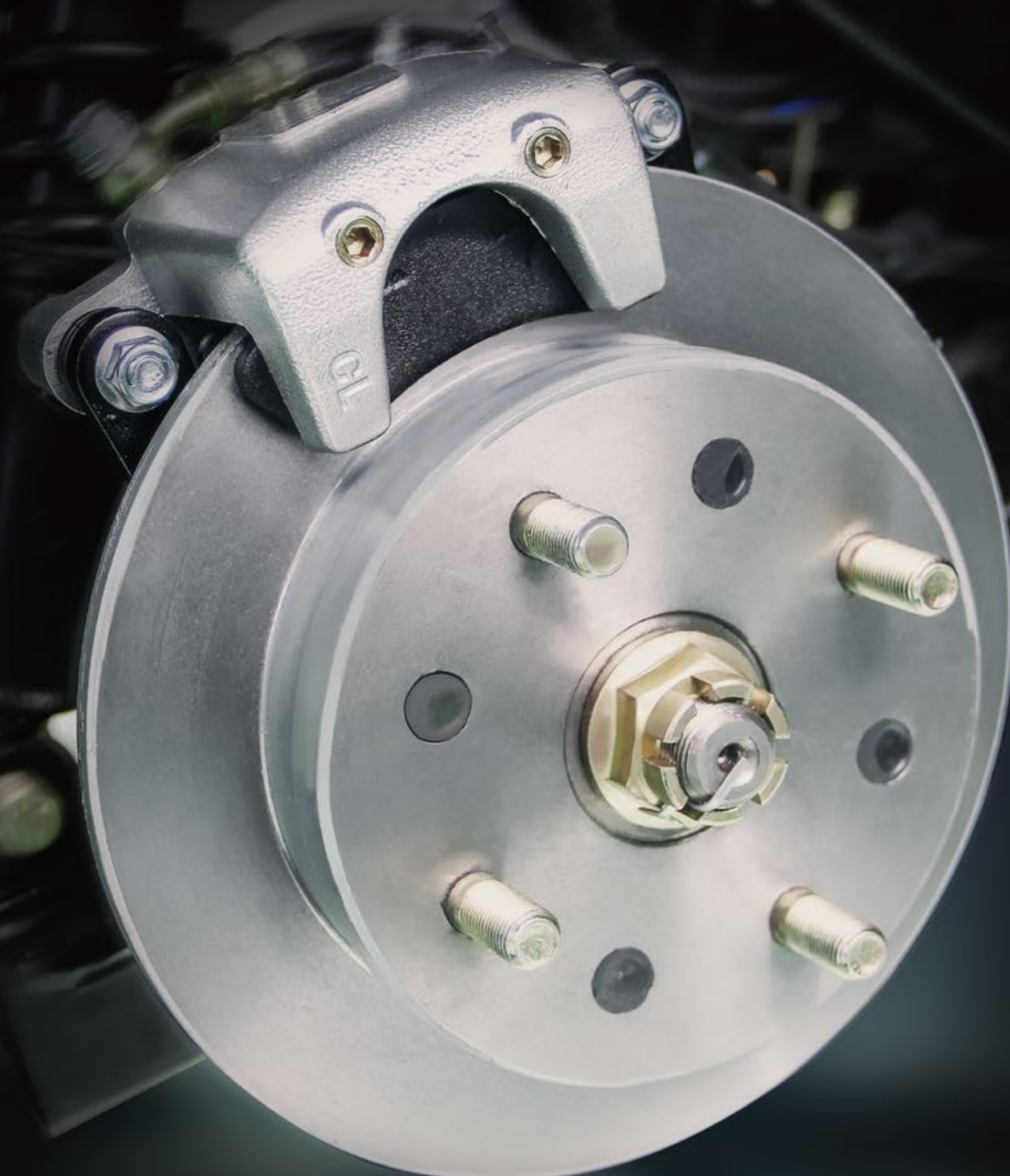
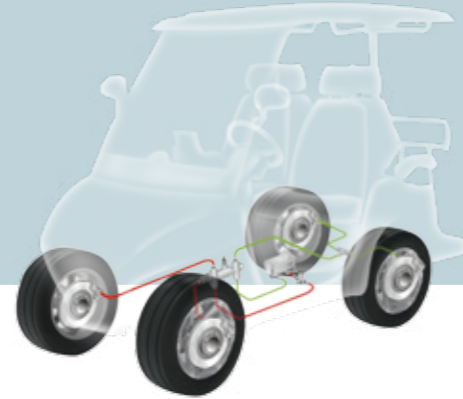

Less Weight



More Agile and
Reliable



Shorter Stopping
Distance With 4 Wheel
Disc Brake



Lower Maintenance
Cost



MULTI-FUNCTIONAL DASHBOARD

STEERING WHEEL

- VOLUME CONTROL
- CELLPHONE CALL
- MODE SELECTION
- HORN
- MEDIA CONTROLS

TOUCH SCREEN

- BLUETOOTH
- VIDEO
- MUSIC
- RADIO
- AUX

- CELLPHONE CALL
- SPEEDOMETER
- GEAR INDICATOR
- LIGHT INDICATORS
- BATTERY SOC

SWITCHES

- STORAGE COMPARTMENT
- POWER BUTTON
- DIAL GEAR SELECTOR
- VOLUME CONTROL
- HAZARD LIGHTS



ALL LED

LIGHTING



***Beam At The Darkness !
Eco-Friendly .Cost-efficient.Long Lasting.Hassle-free.***

Our personal transportation vehicles come standard with LED lights: high beams,low beams, daytime running lights, turning signals and brake lights for a brighter ride. Our lights are more powerful with less drain on your batteries, and deliver a 2-3 times wider field of vision than our competitors, so you can enjoy the ride worry-free, even after the sun goes down.

TILTABLE LAMINATED WINDSHIELD

With a rotary switch, the tilt angle of the laminated windshield is easy to be adjusted. Then just enjoy the cool breeze skating through tilted windshield.



FRONT TRUNK

Touch the associated open button on the key fob to pull the hood up. Then you will find an additional storage space under the hood.



BUILT-IN REMOVABLE REFRIGERATOR

Top-quality and convenient, built-in removable refrigerator is usually best suited for our cart and also a great option for vehicle owners that want flexibility of it.



LITHIUM BATTERY

- ULTRA SAFE
- NO MAINTENANCE
- ALUMINUM PACK
- 5-YEAR WARRANTY

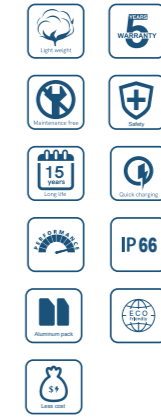

The lithium-ion battery packs with integrated golf cart battery system. They are designed to replace the lead-acid batteries, which are available for drop-in replacement in golf carts easily.

The benefits of lithium-ion battery include lighter weight, shorter charging time, longer life, free maintenance and less electricity bills. Our battery has an integrated management system which includes an On/Off switch and a state-of-charge(SOC) gauge.



MODEL:130Ah



25A Adaptive Charger



Mobile & PC Live Monitor App

DETAILS



STEREO SYSTEM

Touch the Media Player on the touchscreen to play various types of media through your cart's stereo system.



MICROPHONE

Internal microphones have the advantage of already being available in the cart for other applications like cellphone calls.



ADJUSTABLE SEATS



1. SEAT SLIDE BAR

Move the seats forward or backward.

2. BACKREST TILT

Adjust the tilt angle of the backrest.

3. RETATABLE ARMREST

It can rotate in 90 degree and provide an ergonomic support for your cantilever elbows.

4. STANDARD SAFETY BELT

Standard with three-point safety belts in the front seats and two-point safety belts in the rear seats.



USB CHARGING PORT

USB charging port keep you charged on the go.



STORAGE COMPARTMENT

Newly designed dash has large, dual-sized storage compartment, room for more items like keys and mobile devices.



DETAILS



ELECTRIC KEY FOB

It allows you to press buttons to open the front trunk, accessing the cargo area.



ACCELERATOR / BRAKE PEDAL

The accelerator is on the right. The brake is on the left.



CANOPY

Provides protection against the sun and rain. Its color is consistent with the vehicle body.



STANDARD WIPERS

Ensure you have a clean, clear view of the road ahead at all times.



CHARGING PORT

The vehicle can be fully charged within 5 hours and delivers more than 60km of driving range.



LED LOGO LIGHT

Shows our brand name 'EVOLUTION' on the rear canopy, cool and futuristic.



TAIL LIGHTS

Tail lights include LED brake lights and LED turning signals.



REAR HANDRAIL

Optional golf cart bag holder kit.



PPG PAINTS

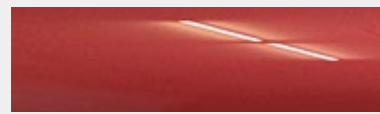

FLAMENCO RED

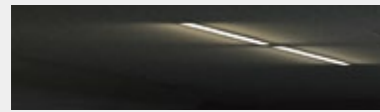

BLACK SAPPHIRE



PORTIMAO BLUE



MEDITERRANEAN BLUE

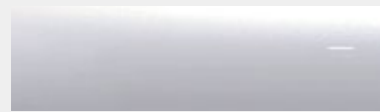

MINERAL WHITE



ARCTIC GRAY

SEAT COLOR



FLAMENCO RED



MEDITERRANEAN BLUE



ARCTIC GRAY



MINERAL WHITE



PORTIMAO BLUE



BLACK SAPPHIRE

WHEEL INSERT COLOR OPTIONS



FLAMENCO RED



MEDITERRANEAN BLUE



ARCTIC GRAY



MINERAL WHITE



PORTIMAO BLUE



BLACK SAPPHIRE

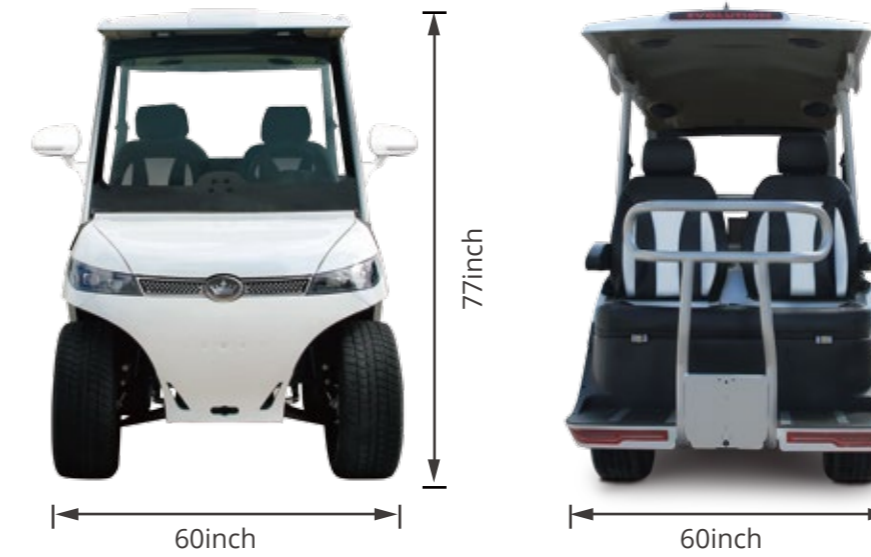

DIMENSIONS

DEL3023G2Z MODEL

● Rated Passengers (person)	4
● System Voltage (V)	48
● Motor Power (kw)	6.3
● Charging Time (H)	5-6
● Dimension (inch)	119×60 (rearview mirror)×77
● Wheelbase (inch)	64
● Wheel Tread (front/rear inch)	39.37/39.17
● Driving Range (full load miles)	≥40
● Maximum Speed (mph)	13/25
● Braking Distance (feet)	≤11.5
● Minimum Turning Radius (feet)	11.8
● Maximum Gradability (full load)	25%
● Curb Weight (lbs)	1168 (front axle 441/rear axle 727)
● Maximum Gross Weight (lbs)	1874
● Minimum Ground Clearance (inch)	6
● Suspension System	Single A-Arm (front)+Triangle Arm Suspension (rear)